

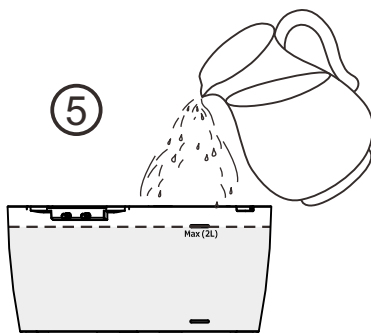

Quick Startup Guide

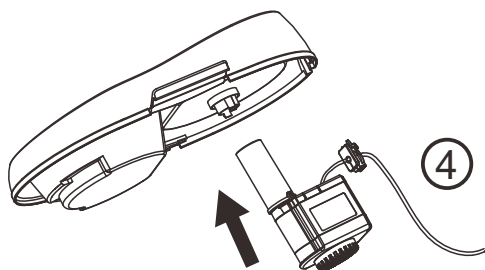

VIDEO

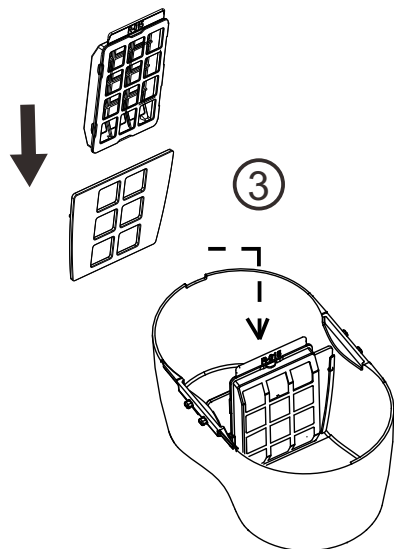
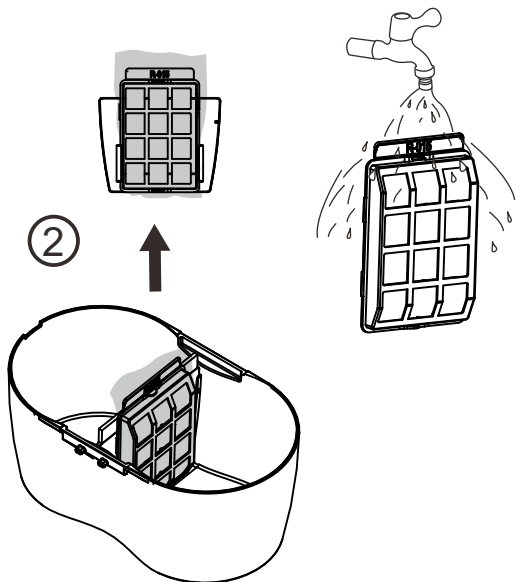
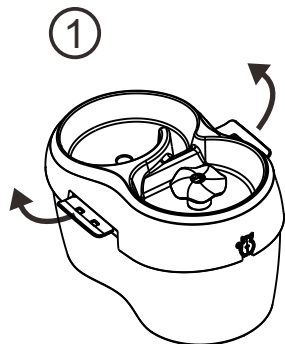
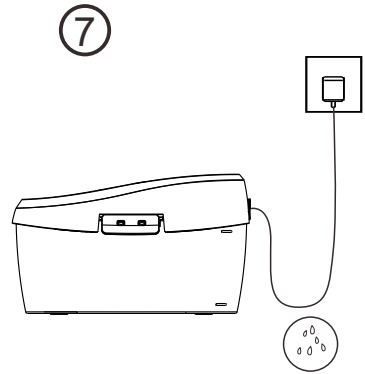
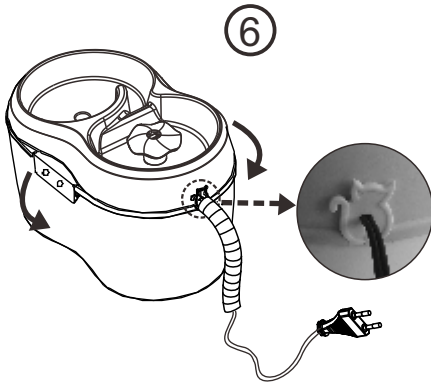

Dental Care

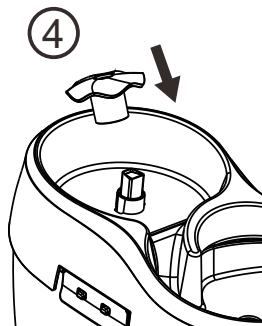
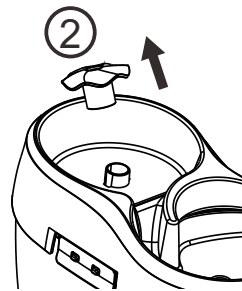
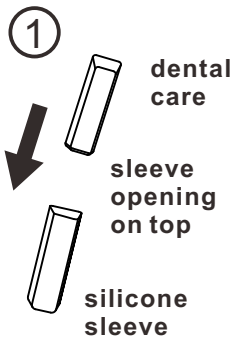



Fresh & filtered water encourages your cat to drink more water leading to a healthier & happier cat. With Dental Care by Cat H2O your cat can improve daily oral hygiene while simply drinking water. "Like" & "Follow" Cat H2O on Facebook to stay connected and see our latest offerings.

www.myCatH2O.com

Important Safety Precautions:

WARNING — DO NOT RUN DRY

- Do not use outdoors. For indoor household use only.
- Cat H2O is meant to run continuously as long as water level is maintained & it is cleaned regularly. CHECK THE WATER LEVEL REGULARLY to prevent damage to the water pump, as water may be consumed or evaporated causing the pump to run dry. Marking for the minimum water level can be seen near the back of the lower bowl.
- Keep the fountain away from the wall outlet and other electrical appliances. Cat H2O should always be positioned below the wall outlet to prevent any possible water drops reaching the electrical outlet. If the fountain fails, make sure that water cannot go to the wall outlet and / or other electrical appliances.
- Only use this fountain and its components for its intended use as described in this manual.
- Do not touch the power supply if your hands are wet.
- Do not operate Cat H2O if there is a damaged power cord. Replace defective or damaged parts by the manufacturer or its service agent or a similarly qualified person in order to avoid hazard.
- Keep this manual for future reference.
- Weight of Cat H2O when filled with water is about 2.5kg (5.5lbs)
- Always unplug or disconnect Cat H2O from the outlet before cleaning the fountain or any parts.
- Always unplug the power plug if not in use.
- Never use the fountain and/or its accessories if it is damaged, if it is not working correctly or if it has been dropped.
- Close supervision is necessary when any electrical appliance is used by or near children or pets.
- Visually inspect the power cord & its protective tube daily. Replace protective tube when damaged / chewed. Do not operate fountain if there is a damaged cord. Only replace the water pump obtained from the manufacturer or its service agent.
- Some animals might be sensitive to plastic. If your pet shows signs of an allergic reaction to the fountain, please discontinue use until you have consulted a veterinarian.
- Dental Care by Cat H2O: Stop using dental care if your cat experiences vomiting, diarrhea or signs of discomfort. For pets with allergy or medical condition, consult veterinarian before use.

What's in the box:

1. Lower Bowl - holds 2L (2.1 quart) of water
2. Upper Bowl
3. Spout
4. Water pump
5. Strainer cover – protects the pump from hair & debris.
6. Cord bushing
7. Protective tube
8. Filter pad
9. Filter grate
10. Dental Care tablet & silicone Slow Dissolve Sleeve

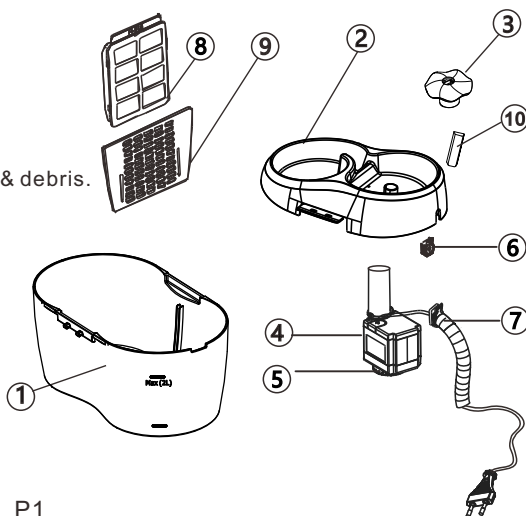

Operation Instructions:

1. Carefully unpack and check the fountain for any damage. Should there be any damage, please return the product to your retailer immediately with your receipt.
2. Remove upper bowl by lifting the clips on the 2 sides (Fig. 1)
3. Pre-Cleaning: Remove all parts, including water pump, filter pad & filter grate and rinse thoroughly under water (Do not use soap or other cleaning agents). Mount filter pad on to the filter grate (Fig. 2), and push filter grate all the way down the slot. Note: Rinse the Filter Pad before inserting in filter grate.
4. Water pump & strainer cover are pre-assembled. Ensure the pump's outlet hole is connected to connection pipe, then connect to the bottom of the upper bowl. (Fig. 3)
5. Check that the power cord bushing is properly positioned and place into the bushing mount on the upper bowl housing. (Fig. 5)
6. Fill water as indicated "Max" on the Lower bowl (Fig. 4). This is important for initial operation as the water pump will not operate properly with less water. This fountain holds approximately 2L (2.1 quart) of water and weights about 2.5kg (5.5 lbs).
7. Once the water is filled, assemble upper bowl housing and lower bowl, making sure the power cord & bushing is located in the correct position. Secure the bowl properly using the clips on the 2 sides (Fig. 5)

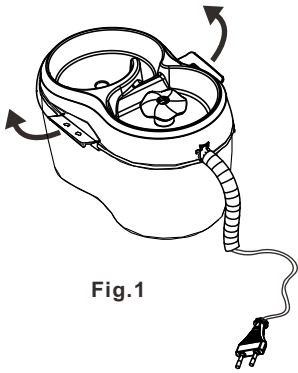

Fig.1

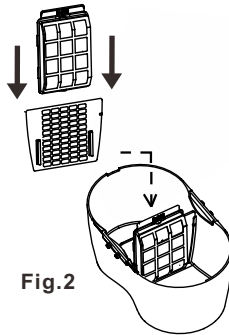

Fig.2

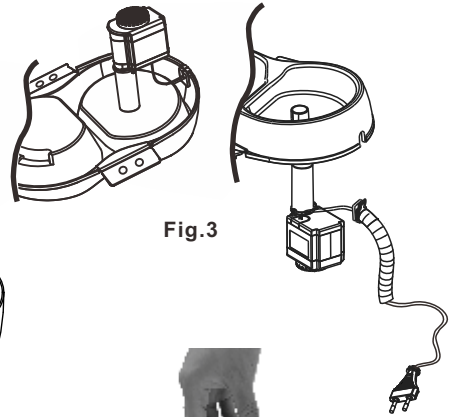

Fig.3

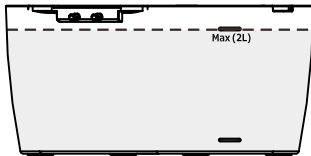

Fig.4

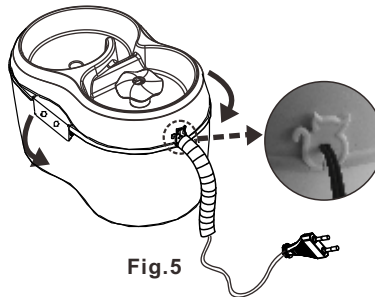

Fig.5



Fig.7

8. Position the fountain in your desired location. When the Cat fountain is filled with water, please hold the bottom (Fig. 6B), do not grip only at the two clips (Fig. 6A). If placing on a carpet or wood flooring, use a protective mat or other durable, water resistant surface. This will help protect your floor from splashing or water drops from your pet.
9. To insert Dental Care, remove water spout, insert 1 block of Dental Care into the silicone Slow Dissolve Sleeve, then place into water outlet and replace the water spout. 1 tablet of Dental Care lasts 3~4 days in continuous normal use. Check the Dental Care tablet regularly as it will be visible in the spout. Replace tablets for complete and continuous care for your cat. Always unplug your fountain before replacing Dental Care tablets. Refer to Dental Care section for more information. (Fig. 7)

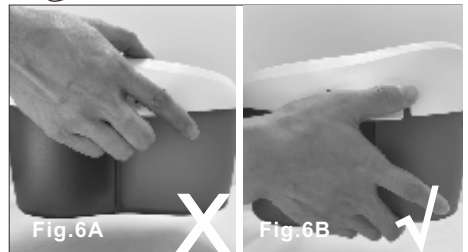

Fig.6A

Fig.6B

10. Before you plug in the fountain, make sure the power cord, protective tube and your hands are dry. Plug the fountain into the wall outlet so that the fountain is positioned below the wall outlet. (Fig. 8).
11. Always unplug the fountain before adding water. As water is consumed by your pet or has evaporated, simply pour water to the upper bowl only to the "Max" indicator at the lower bowl. (Fig. 4) LOW WATER level is evident if the pump is NOT pumping water at full capacity, making noise or if you can see air bubbles being pumped with low water output. **Never leave your pump running dry** or you may risk pump failure.

Dental Care by Cat H2O:

A sample Dental Care by Cat H2O is supplied with each Cat H2O water fountain, providing daily oral hygiene for your cat while simply drinking water.

- Protects against plaque & tartar build up, for healthier gums
- Calcium supplement for stronger teeth
- 99% odor, taste & color-FREE, even the pickiest cat will enjoy their water
- Contains Glucose Oxidase, an enzyme that is scientifically proven to react with glucose, forming a powerful cleaning and anti-bacteria agent. Simply it helps keep teeth clean.
- Dental Care Tablets are formulated & made in Australia.
- Also suitable for dogs.
- Each tablet will provide 3~4 days of protection.
- Ingredients: Deionized water, Dental plaster, Glucose oxidase enzyme, Potassium sorbate.
- Store Dental Care in a cool dry place out of direct sunlight. Keep out of reach of children and pets. Not for ingestion.

Check the Dental Care tablet regularly as it will be visible near the top of the water spout.

Replace tablets for complete and continuous care for your cat.

To purchase replacement Dental Care tablets visit your local retailer, email to service@myCatH2O.com or visit our website for more information. Item number is **DH08DC**

Tips: Setup an automatic monthly FILTER CHANGE reminder

To setup an automatic monthly FILTER CHANGE reminder on your phone's calendar app, simply scan the QR code & follow the instruction.



Maintenance:

1. To keep the fountain & water clean, maintenance should be done weekly.
2. Always unplug or disconnect Cat H2O from the outlet before maintenance.
3. Carry the unplugged fountain to the sink as water may spill from the bowl.
4. Remove upper bowl by unsnapping the 2 clips (Fig. 1) Place this aside, note that the water pump and spout will remain connected to the upper bowl.
5. Remove filter grate & remove the filter pad, then empty out the remaining water from bowl.
6. Remove the spout from upper bowl with a gentle pull, take out the silicone sleeve & remove any remaining Dental Care tablet bits. The water pump is removed by turning it anti-clockwise and then a gentle pull (Fig. 9). Reminder – DO NOT lose the small silicone power cord bushing.

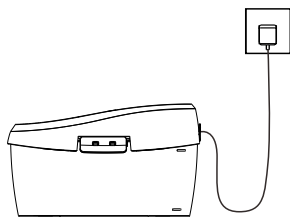

Fig.8

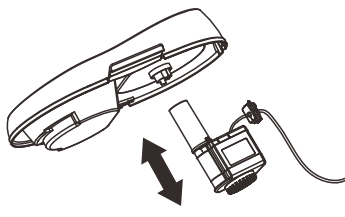

Fig.9

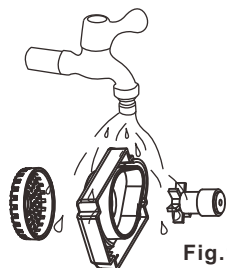

Fig.10

7. Disassemble the pump (see "Pump Maintenance" section for instructions). Rinse the strainer cover, front cover and the impeller under running water & remove any debris & hair that has build up in the strainer. (Fig. 10)
8. Once all the parts are disassembled, clean fountain parts with warm water and mild soap, then rinse in clean water only. The fountain parts are top rack of the dishwasher safe. **Never place the water pump and filter pad into a dishwasher**, only the plastic pieces.

9. Should the water pump appear dirty, see “**Pump Maintenance**” section for instructions for cleaning the water pump. It is also recommended to clean the impeller of the pump once a month to ensure smooth and reliable performance.
10. Filter pads should be changed about every 4 weeks depending on water condition. We recommend to change the filter pad more frequently if you have multiple pets or pets that produce more saliva.
11. Filter pads can be rinsed by water during cleaning of the fountain. **Never use soap to clean the filter pad and NEVER place filter pad into a dishwasher.**
12. Each filter pad combines SPONGE FILTERS that cleanse the water of food, fur & debris and CERAMIC BEADS that adsorbs bad odors & other chemicals from tap water and improves water taste as well.
13. To purchase replacement filter pads visit your local retailer, email to us at service@myCatH2O.com or visit our website for more information. Item number is **R-015-CH**.
14. Once all your fountain parts are clean, reassemble them according to the “Operation Instructions” section.
15. Visually inspect the power cord & its protective tube. Do not operate fountain if there is a damaged cord. Replace protective tube if damaged / chewed. Only replace the water pump using parts from the manufacturer or its service agent.
16. Before you plug in Cat H2O, check that the Dental Care tablet is inserted correctly to provide daily oral hygiene.

Pump Maintenance:

1. Cat H2O recommends to clean THE IMPELLER of the pump once a month to ensure smooth and reliable performance. This is the part that pushes water.
2. During weekly maintenance remove the water pump from the upper bowl.
3. Grab the front cover and remove it from the pump. The strainer can also remove from the front cover. (Fig. 11).
4. Remove the impeller assembly (by using your fingers to pull the blades), be sure NOT to lose the 2 rubber tips at each end of the impeller assembly. Clean and brush using an old toothbrush under running water. Rinse the pump’s cavity. For demo video - search YouTube: **Cat H2O Pump maintenance**
5. Reassemble the pump and mount it back to the upper bowl. Ensure that the strainer is clean and that any hair or debris is removed, then connect it to the pump’s inlet hole.
6. **NEVER** put the water pump & its parts into the dishwasher.

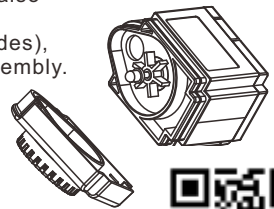



Fig.11



Fountain in different environments:

1. If you live in an area with “Hard Water”, white mineral deposits could be seen at the water pump and on various fountain plastic parts. The buildup of mineral deposit could eventually damage the water pump, to avoid and maintain good performance, we recommend to carry out “Pump Maintenance” more frequently.
2. Mold or algae could be a result of a humid environment or if the fountain is exposed to direct sunlight. IF MOLD OR ALGAE occurs, during weekly cleaning use a diluted bleach solution (10% bleach & 90% water) to clean all plastic parts (Never wash the filter pad in bleach solution). After cleaning, rinse all parts very well under running water. To prevent further algae growth, place the fountain in a position with less sunlight.

Trouble shooting guidelines:

<p>Water pump doesn't work</p>	<p>(1) make sure the plug is connected & water is filled to “Max” on the Lower bowl (2) Try unplugging and plugging the unit to restart the pump; always make sure your hands are dry.</p> <p>For fountains already in use – some thinner pet hair can go through the strainer and block the water pump’s impeller. Refer to “Pump Maintenance” section above, or see demo video - search YouTube: Cat H2O Pump maintenance</p>	
--------------------------------	---	--

My pet is not drinking from the fountain	Your pet may need a little bit more time to adjust to drinking from a fountain.
Water level is split into 2 levels on the lower bowl	Filter pad is blocked. Please wash the filter pad every week. Replace a new filter pad every 4 weeks.
Water turning yellow	Time for maintenance; change the filter pad
Water from pump is weak & with some air bubbles	(1) This is a sign of "low water level", fill water as indicated "Max" on the lower bowl. If water is full & flow remains slow, refer to "Pump Maintenance" section to clean the impeller of the pump. (2) Check strainer under the pump and remove any debris.
The pump is pretty quiet, but becoming noisier than usual.	Fill water level back to "Max" fill level indicator.
Always seems to be out of water	Unplug the unit and check for leaks from the fountain. If there are no leaks, your fountain is fine. Fill up with water more regularly as fresh & filtered water encourages your pets to drink more often.
Can the filter be washed in a dishwasher?	No, because ceramic beads from the filter pad will adsorb cleaning chemicals and cannot be rinsed off. Just change the filter pad.
How do I buy additional filters?	Visit your local retailer, or email us at service@myCatH2O.com or visit our website for more information. Item number for the filter pad is R-015-CH.
The Dental Care tablets didn't have a strong mint flavor; are they working?	Both dogs and cats are more sensitive to flavors and odors than humans. Dental Care is formulated with a tiny amount of added flavor, even the pickiest pet will enjoy their water
Dental Care seems to leave some grit at the bottom of the bowl, is this OK?	Some tablet binder may appear in the reservoir and is not harmful to pets; just clean the bowl during weekly maintenance.
The pump is noisy even if the water is at Max level	Unplug and plug again the pump until it runs silently. It is about adjusting the phase of the electrical current. The pump is not faulty.



Warranty:

Cat H2O fountain & its parts are warranted to be free of defects in material and workmanship for one (1) year from the date of purchase. Retain your dated receipt as proof of purchase. If defective, please email to service@myCatH2O.com

The water pump is backed by a 3 year Limited Warranty by AA Aquarium. Conditions for Limited Warranty include:

1. Use of filter pad, filter grate & strainer to prevent foreign objects entering into and damaging the water pump.
2. Pump maintenance to be carried out monthly to ensure smooth and reliable performance.

Free warranty service will **NOT** be provided if (a) it has been explicitly or implicitly modified, tampered with or altered, or repaired in any way by persons other than technicians of the Company or (b) it has been damaged through misuse, negligence, liquid ingress, accident or natural calamities or (c) it has malfunctioned due to power interruption or abnormal voltage input or (d) it is a result of lack of cleaning, debris or mineralization from "Hard water" or (e) it is a result of insufficient water causing the pump to run dry.

Replacement of Impeller is not included in Warranty.

For service, clients will be responsible to transporting the unit to and from our repair service centers. For more details, please email to service@myCatH2O.com